

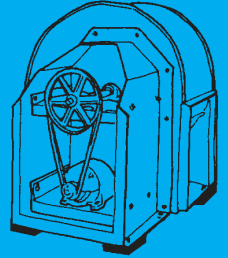

# MASON

## MINI SUPER W PADS

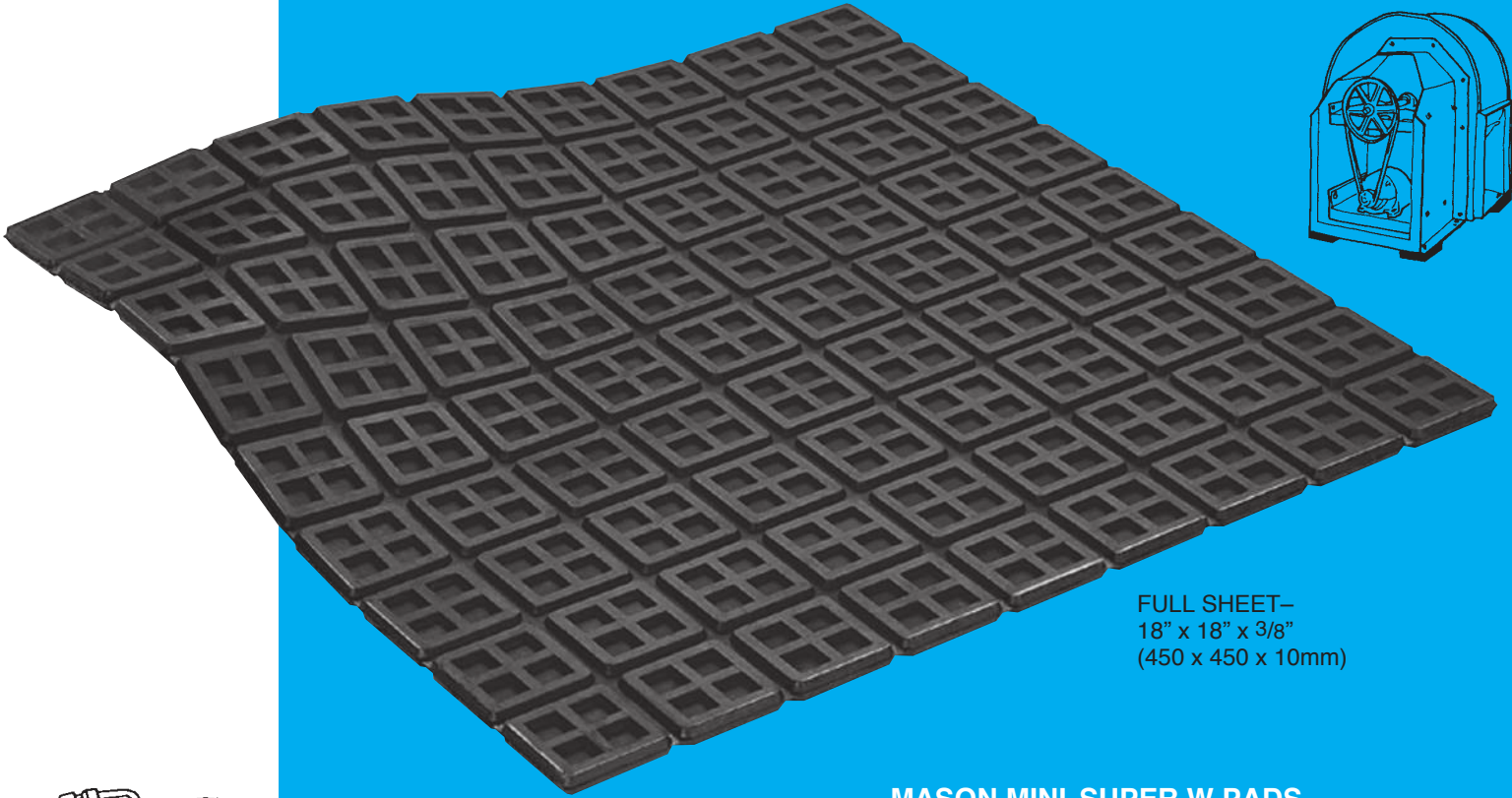

FULL SHEET—  
18" x 18" x 3/8"  
(450 x 450 x 10mm)

**MASON MINI SUPER W PADS ARE MOLDED IN NATURAL RUBBER** for maximum resilience and vibration isolation. Contains anti-oxidants and anti-ozonants to improve aging.

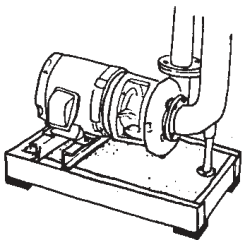
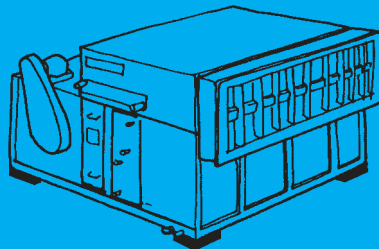
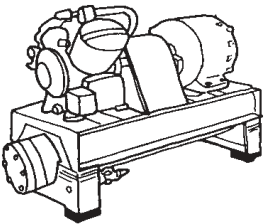

Standard size 18" x 18" x 3/8" (450 x 450 x 10mm) consists of 81 - 2" (50mm) modules. The 2" (50mm) squares are separated by a thin web that is easily cut to provide evenly dimensioned pads such as 2" x 2" (50 x 50mm), 2" x 4" (50 x 100mm), 4" x 4" (100 x 100mm), 6" x 8" (150 x 200mm), etc. Our Mini Super W pad is one of the thickest, most versatile and efficient pads on the market.

#### METRIC EQUIVALENTS

18" x 18" x 3/8" = 450 x 450 x 10mm

2" x 2" x 3/8" = 50 x 50 x 10mm

2" x 4" x 3/8" = 50 x 100 x 10mm

4" x 4" x 3/8" = 100 x 100 x 10mm

6" x 8" x 3/8" = 150 x 200 x 10mm

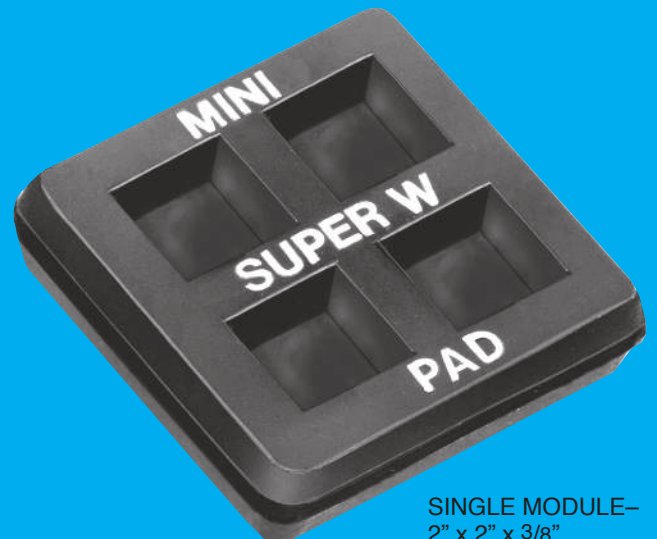

SINGLE MODULE—  
2" x 2" x 3/8"  
(50 x 50 x 10mm)

Pads can be used to reduce noise, high frequency vibration and impact from typical machines as follows:

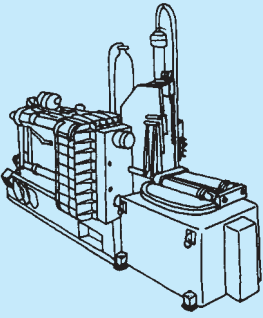

- Motor Generators
- Transformers
  - Diesel Generators
  - Punch Presses
  - Lathes
  - Saws
- Power Presses
- Drill Presses

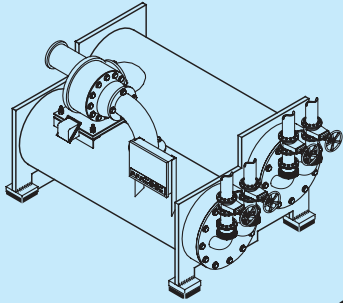
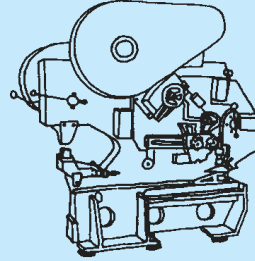
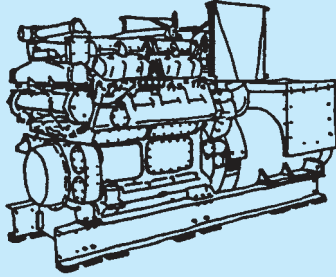
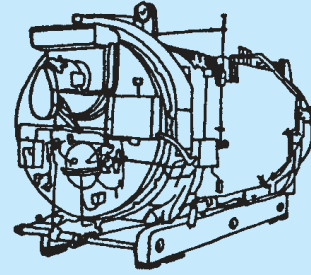

- Chillers
- Compressors
- HVAC Units
- Vent Sets
- Pumps

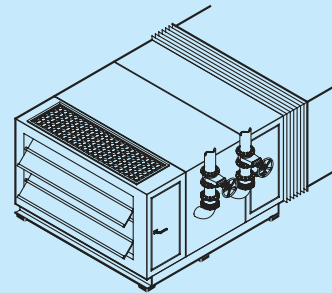
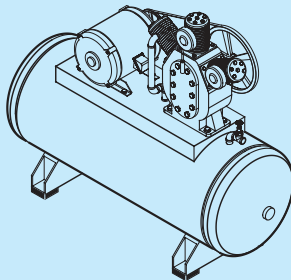
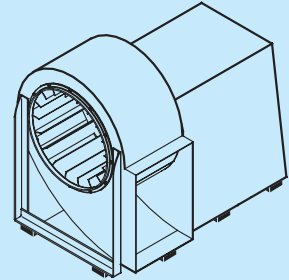

PADS MAY BE STACKED WITH 16 GAUGE 1.6mm SHIMS BETWEEN LAYERS FOR INCREASED DEFLECTION.

**MINI SUPER W LOAD RATINGS**

15% DEFLECTION		15% DEFLECTION		20% DEFLECTION	
Load per 2" x 2" Square (lbs)	Load per 50x50mm Square (kgs)	Recommended Load per Area (lbs/in <sup>2</sup> )	Recommended Load per Area (kg/mm <sup>2</sup> )	Maximum Load per Area (lbs/in <sup>2</sup> )	Maximum Load per Area (kg/mm <sup>2</sup> )
180	80	45	.032	60	.043

Standard Durometer 45±5

Mini Super W Pads should be used in full squares. Select the minimum number of squares required and design pad to the most convenient square or rectangle. The use of additional squares results in more conservative loading.

**British Units Example—**

Load is 980 lbs. 45 Duro capacity is 180 lbs.  
980/180 = 5.44 squares (Use 6 square modules).

Pad may be 2 modules x 3 modules (4" x 6")  
or 1 module x 6 modules (2" x 12")

**Metric Units Example—**

Load is 5000 kgs. 45 Duro capacity is 80 kgs.  
5000/80 = 62.5 squares (minimum).

Pad may be 8 modules x 8 modules (400 x 400mm)  
or 7 modules x 10 modules (350 x 500mm)  
or 6 modules x 11 modules (300 x 550mm) etc.



**MASON INDUSTRIES, INC.**

350 Rabro Drive, Hauppauge, NY 11788 • 631/348-0282 • FAX 631/348-0279  
2101 W. Crescent Ave., Suite D, Anaheim, CA 92801 • 714/535-2727 • FAX 714/535-5738  
Email info@Mason-Ind.com or info@MasonAnaheim.com • Website www.Mason-Ind.com